



UNIQUE DESIGN FOR BOUNDLESS POSSIBILITIES

MUNDUS glass patch fittings. Discover their new, inspiring clean design and unique ease of installation.

CONTENTS



Range overview
**Design aspects/
Colors and finishes**
4-5



Applications and standard configurations
6-7



Suitable for laminated safety glass (LSG)
8-9



Quick and easy installation
10-11



Glass cut-outs
12-13

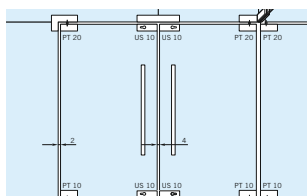

Technical details
14-15



Convincing benefits:

MUNDUS is a line in patch fittings that offers inspiring design combined with simple, fast installation.

- Clear design, no visible fixings
- Wide range of finishes, colors and materials

UNIQUE DESIGN UNIQUELY EASY TO INSTALL



- Fast installation, adjustment even when mounted
- Always fits – adjusts to different glass thicknesses without the need to change gaskets
- Suitable for laminated safety glass employing the established DORMA Clamp & Glue technology for high demands on quality and safety
- Easy to retrofit and integrate in existing systems – patch fittings and locks can be readily replaced by MUNDUS components

THE FREEDOM OF VERSATILITY

Individual design options with different finishes, colors and materials.

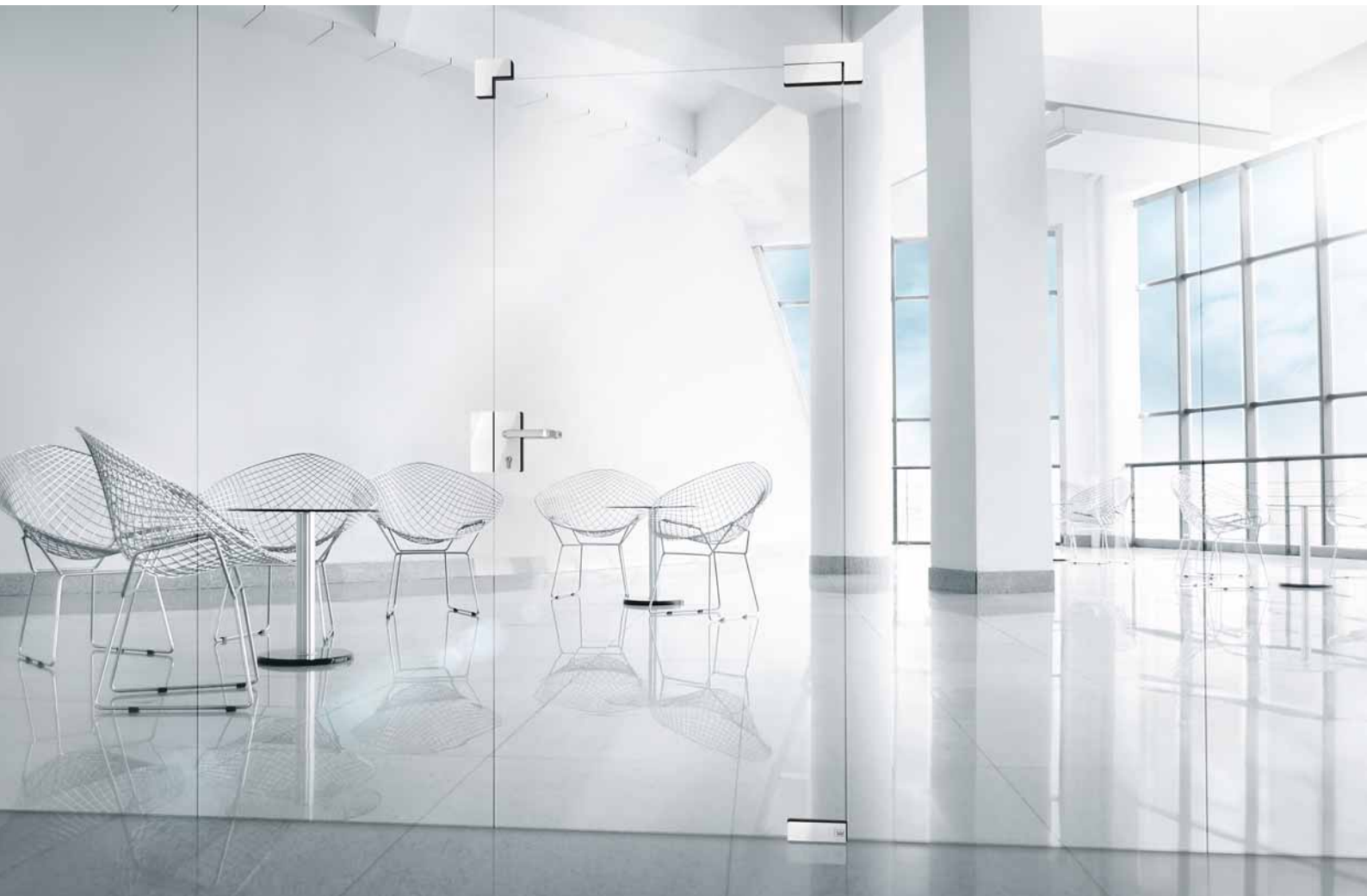

Visual appeal: the trim surrounding the cap of the patch fitting has the appearance of an elegant shadow.

Sophisticated design

MUNDUS patch fittings are striking in appearance thanks to their elegant shape with straight edges and radiused corners, their high-quality materials and the care and workmanship that goes into

their manufacture. There are no fixings to disrupt the smooth surface. And to ensure that their alluring appearance lasts, the cap consists of 2 mm thick – and thus particularly robust – material in the form of either stainless steel or aluminum.



Wide choice of finishes

Various attractive collections are available to adapt the patch fittings to the architectural finishes and color scheme of the build.

The focus is on providing a wide choice of materials with a select, graduated spectrum from light to dark, from

matt to textured and highly polished, and from integrating to accentuating.

Moreover, this choice of finishes, colors and materials is under constant review and development in order to keep abreast of changing market requirements and customer expectations.



White P 100 Semi Gloss



Silver P 600 Semi Gloss*



Cast P 612 Effect*



Champagne P 718 Semi Gloss*



Bronco P 740 Semi Gloss*



Dark Havanna P 280 Semi Gloss*



Silver N 600 Satin



Niro S 700 Satin



Dark Niro N 701 Satin*



Niro S 700 High Gloss*



Antique Brass N 744 Satin*



Black Bronze N 790 Satin*



Glass White G 810 High Gloss



Glass Black G 880 High Gloss

Trend collection

Powder-coated **aluminum** surfaces aligned to current trends in interior design.

Exclusive collection

Treated metals such as anodized **aluminum** or polished **stainless steel**.

Glass collection

Glass finishes enable the fittings to visually merge with glass doors, creating a completely new effect.

* In development, scheduled for availability from 2016

MULTI-APPLICATION SUITABILITY FOR INDIVIDUAL REQUIREMENTS

MUNDUS offers patch fittings for 24 standard systems and numerous customized solutions.

Whether for an open home ambience, attractive office or prestigious shop entrance, visually and technically advanced MUNDUS range of glass architectural hardware offers solutions to a wide range of different requirements.

The extensive portfolio encompasses connection and corner patch fittings for the most common 24 standard systems – such as PT 10, PT 40 or PT 70. Additional special designs aligned to specific room configurations,

including angled models for multi-dimensional configurations that can be installed on either side, i.e. left and right. Around corners – such as the PT 41 and PT 61 – also from part of the range.

- 1** MUNDUS PT 10 and floor pivot or floor spring BTS
- 2** MUNDUS PT 20 & PT 40
- 3** MUNDUS US 10
- 4** MUNDUS GK 20
- 5** Pull handles

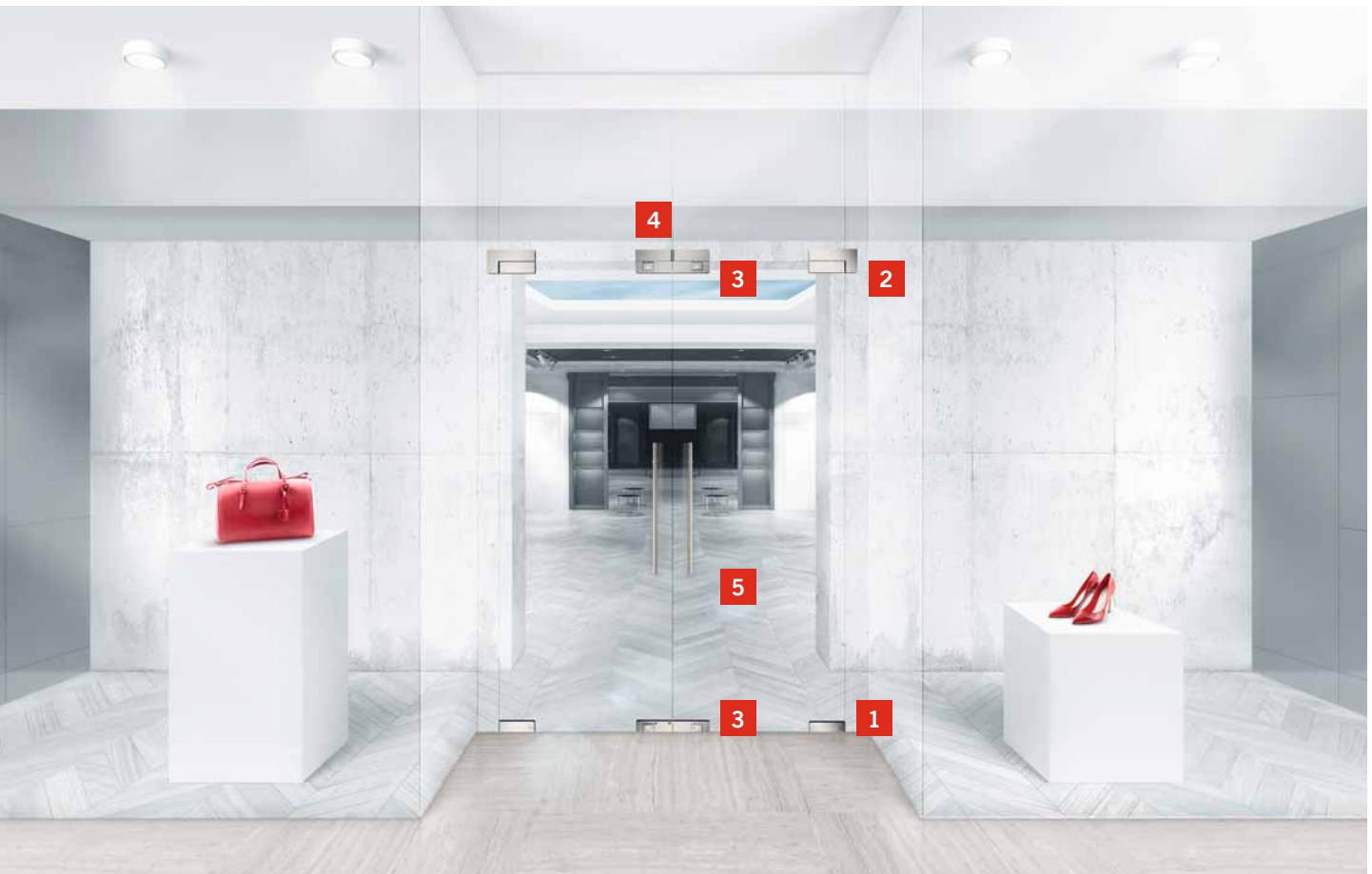

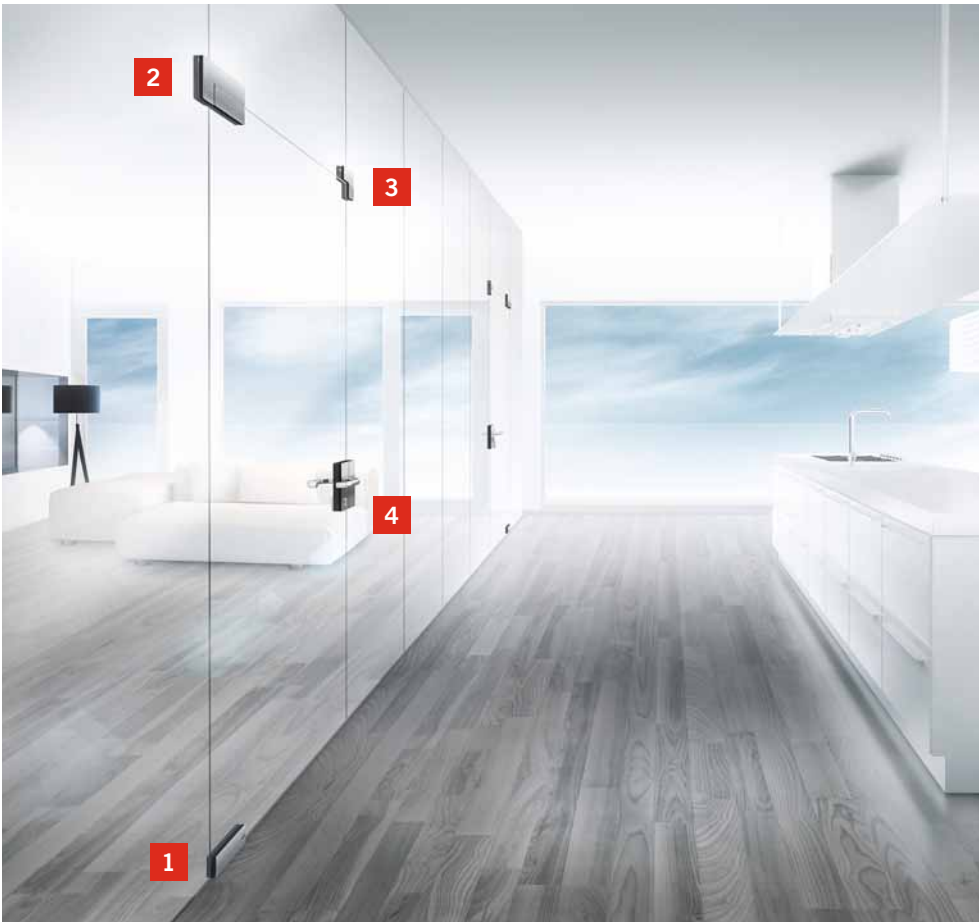

- 1** MUNDUS PT 10 and floor pivot or floor spring BTS
- 2** MUNDUS PT 20 & PT 40
- 3** MUNDUS PT 60
- 4** MUNDUS lock case

A concealed floor spring BTS ensures gentle, convenient opening and closing.



MUNDUS patch fittings for 24 standard systems

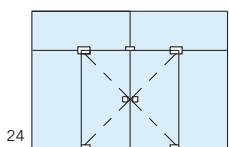
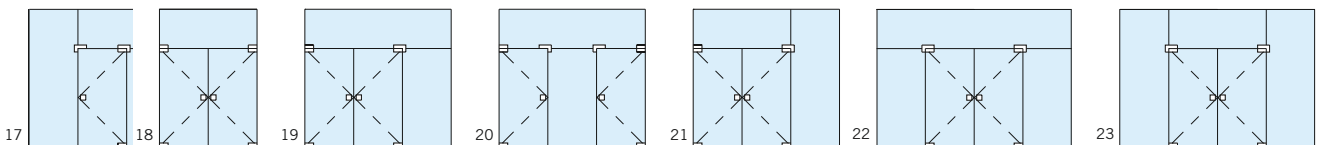
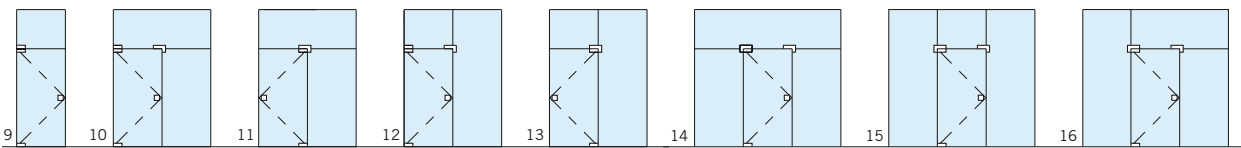
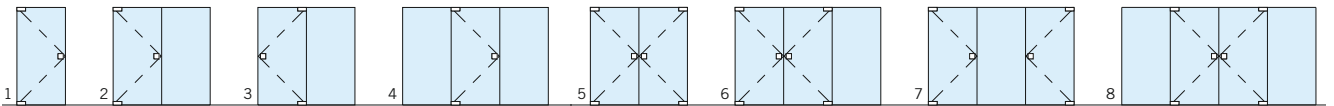

In addition to these standard systems, DORMA also offers customized solutions for individual requirements.

SUITABLE EVEN FOR LAMINATED SAFETY GLASS

Established Clamp & Glue technology ensures secure hold and safety of glass systems using MUNDUS patch fittings.

Offering reliable hold – established Clamp & Glue technology

The established DORMA technology for the installation of laminated safety glass. Additional adhesive bonding ensures a firm hold with the fitting permanently joined to the glass.

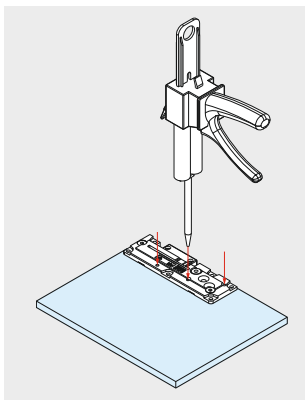

Easy bonding operation following clamp fixing:

- Adhesive injected into inlet holes
- Operation complete once adhesive emerges at the overflow openings at the side of the clamping plate
- Operation repeated on the rear face
- Adhesive needs to be allowed to cure





MUNDUS and laminated safety glass (LSG) – a combination that offers impressive benefits:

- High degree of safety for users, even in the case of large architectural glass constructions
- Integration of sound-absorbing film possible to reduce noise levels
- Switchable glass, e.g. for conference rooms – application of an electric pulse causes the glass to become opaque for privacy
- Maximum residual load-bearing capacity through the use of LSG with semi-tempered glass

EASY TO INSTALL, EASY TO ADJUST

MUNDUS glass patch fittings for easy, smooth adjustability – even when mounted.



The basic MUNDUS patch fitting plate is mounted directly on the glass while the individual cover is simply snapped onto the already installed fitting.



Fast and uncomplicated fixing

With MUNDUS, the entire door can be adjusted with multi-dimensional variability, allowing the vertical gap dimensions to be infinitely adapted and ensuring perfect alignment of the pivot point and the zero position.

Multi-dimensional adjustability even when mounted

Alignment options



Door before alignment

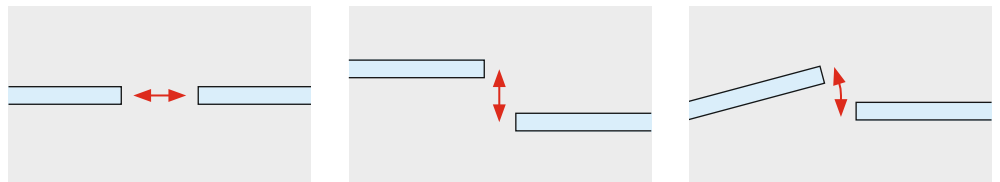

Door after alignment

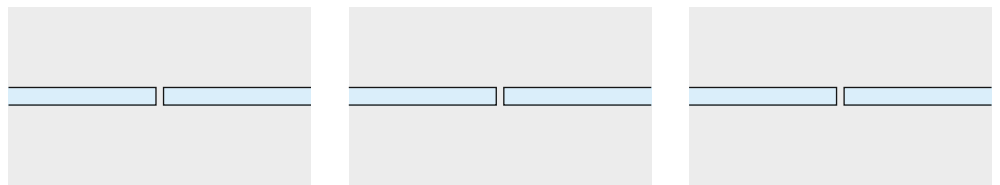

Alignment in the X axis 

Individual adjustment of the pivot point, infinitely variable between 52 and 73 mm.

Alignment in the Z axis 

Infinite variability of the door position to achieve flush alignment thanks to adjustment of up to 1 mm for a glass thickness of 8 mm, or 3 mm for a glass thickness of 12 mm.

Zero position adjustment 

Infinite alignment variability of the door to achieve the correct zero position by adjustment around the axis of rotation in the range +/- 1.5°.

Optimum gap dimensions

Thanks to the highly variable, multi-dimensional adjustability of the patch fittings, the door can be optimally aligned following installation.



For further information and animations, scan in the QR-code.



EASY TO INSTALL, EASY TO RETROFIT

Thanks to flexible settings for glass widths and glass cut-outs.



No special gaskets needed

With MUNDUS, customers will need no gaskets to adjust the base plates for different glass thicknesses, as MUNDUS therefor offers an adjustment.

Instead of gasket replacement, all that is required is

the adjustment of two screws. Only one gasket is needed to avoid direct contact of the glass with the metal body of the patch fitting. And incidentally, the screw connection of the fitting offers additional burglary protection as the fitting cannot be removed from just one side.

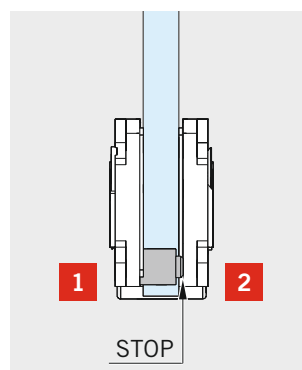

1 + 2 Easy adjustment by two screws instead of gasket replacement.

Easy to retrofit

A patch fitting that will match the most common glass cut-outs worldwide.

MUNDUS can also be retrofitted to existing installations by simply replacing the patch fittings.

Through its variability it is able to cover the most common glass cut-outs used or required around the world, making it particularly suitable as a retrofit solution.

Replacement can be carried out quickly and hassle-free. Simply take off the door, remove the old patch fittings, clean the glass, fit the new patch fittings and hang the door back in place.

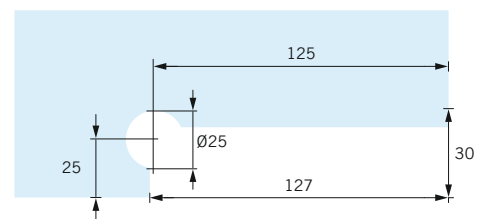
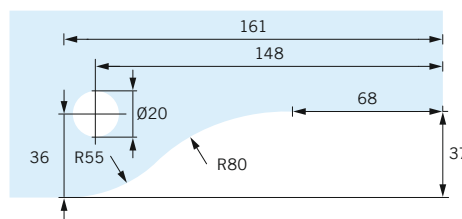
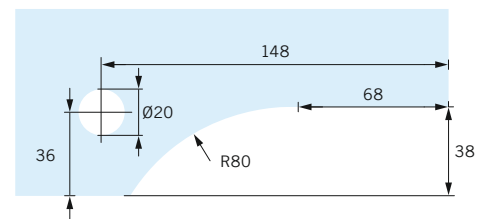
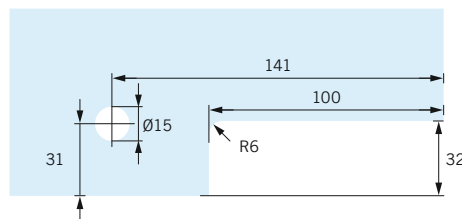

MUNDUS covers the glass cut-outs most frequently encountered around the world.

Suitable for different glass thicknesses

Glass thicknesses of 8–12 mm, 12–15 mm, 15–19 mm and 19–22 mm can be each installed with a single, adjustable fitting.

The extra gaskets that would otherwise have to

be ordered are thus no longer needed.

You always have the right patch fitting to hand – and that means fast installation and more time saved.



Glass thickness: 8–22 mm
Door weights up to 200 kg

SYSTEM VERSATILITY DOWN TO THE LAST DETAIL

MUNDUS – the technical specifications at a glance.

Type selection

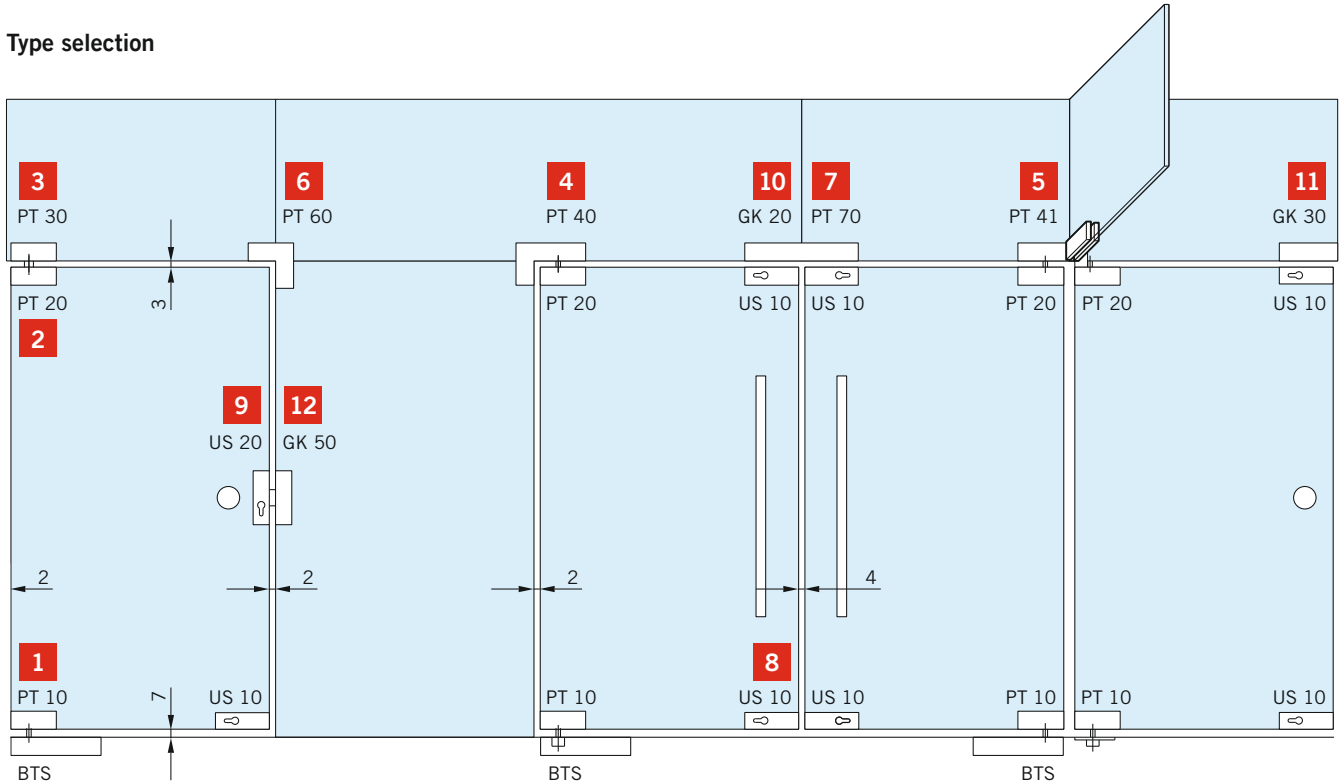

- 1** PT 10 Bottom patch fitting with insert for floor spring or floor pivot
- 2** PT 20 Top patch fitting with plastic socket for 14 mm pin
- PT 22 Top patch fitting with insert for transom-mounted door closer
- 3** PT 30 Overpanel patch fitting with either pivot, stop insert or blank insert
- 4** PT 40 Right angled overpanel patch fitting
- 5** PT 41 Right angled overpanel patch fitting with fin fitting either both sides, just on the left or just on the right
- 6** PT 60 Right-angled connector patch fitting for single-action and double-action doors with blank and stop inserts
- PT 61 Right-angled connector patch fitting for single-action and double-action doors with fin fitting either on both sides, only on the left or only on the right

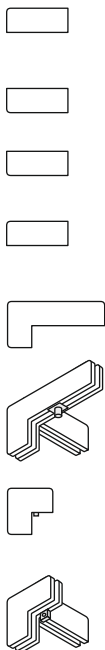

- 7** PT 70 Overpanel connector patch fitting with blank and stop inserts
- 8** US 10 Corner lock for europrofile or KABA locking cylinder
- 9** US 20 Center lock for europrofile or KABA locking cylinder
- 10** GK 20 Double overpanel strike box for corner lock US 10
- 11** GK 30 Overpanel strike box for corner lock US 10
- GK 40 Right-angled overpanel strike box for corner lock US 10
- 12** GK 50 Strike box for center lock US 20

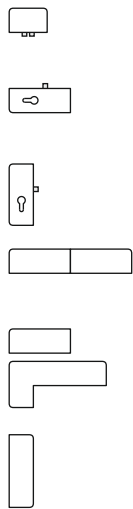

BTS = Floor spring
 GK = Strike box
 PT = Patch fitting
 US = Lock

Applications and features	MUNDUS Premium	MUNDUS Comfort
Max. load-bearing capacity (in kg)	200	150
Possible glass thickness in mm	8-12 12-15 15-19 19-22	8-12
Max. door width in mm	1,300	1,100
Suitable for LSG	•	–
Supported pivot points in mm	55, 65, 70	55, 65, 70
Pivot point adjustability in mm	Infinite 52-73	Infinite 52-73
Adjustability of the door/insert	Multi-dimensional	Multi-dimensional
Cover materials	Stainless steel, aluminum, glass etc.	Stainless steel, aluminum
Test cycles to EN 12400	1,000,000	500,000
Corrosion class to EN 1670	4	4
Materials and finishes (for details please have a look at page 5)		
Trend collection (Powder-coated aluminum surfaces)		
White P 100 Semi Gloss	•	•
Silver P 600 Semi Gloss*	•	–
Cast P 612 Effect*	•	–
Champagne P 718 Semi Gloss*	•	–
Bronco P 740 Semi Gloss*	•	–
Dark Havanna P 280 Semi Gloss*	•	–
Exclusive collection (Anodized aluminum or polished stainless steel)		
Silver N 600 Satin	•	•
Niro S 700 Satin	•	•
Dark Niro N 701 Satin*	•	–
Niro S 700 High Gloss*	•	•
Antique Brass N 744 Satin*	•	–
Black Bronze N 790 Satin*	•	–
Glass collection (Glass finishes)		
Glass White G 810 High Gloss	•	–
Glass Black G 880 High Gloss	•	–

* in development, scheduled for availability from 2016 • standard – no



DORMA Deutschland GmbH
DORMA Platz 1
58256 ENNEPETAL
GERMANY
Phone +49 2333 793-0
Fax +49 2333 793-4950
www.dorma.com